

- Ⓢ ROLLEN-UND KEGELARBEITSAUFLAGE
- Ⓢ SUPPORT DE TRAVAIL À ROULEAUX ET À BILLES
- Ⓢ BALL & ROLLER WORK SUPPORT
- Ⓢ WERKSTEUN MET ROLLEN EN KOGELS
- Ⓢ SOPORTE DE TALLER CON RODILLOS Y BOLAS
- Ⓢ SUPORTE DE TRABALHO COM ROLOS E ESFERAS
- Ⓢ STÅLLBART ARBETSBORD PÅ HJUL
- Ⓢ RULLEBUK OG KUGLELEJEBUK
- Ⓢ ARBEIDSSSTØTTE MED KULE OG RULL
- Ⓢ KUULIEN JA RULLIEN TYÖTUKI
- Ⓢ SUPPORTO A RULLI ED A SFERE
- Ⓢ PODPORA ROBOCZA Z ROLKĄ I KULKAMI

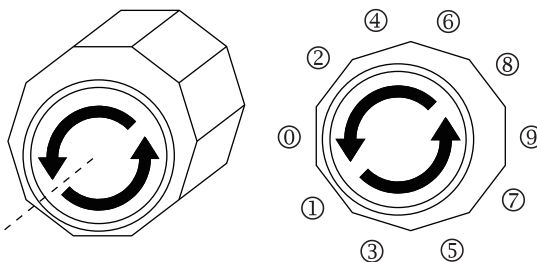

- | | |
|----------------------|----------------------|
| ① 0 | ⑤ + 5.50mm (+ 0.22") |
| ② + 0.50mm (+ 0.02") | ⑥ + 6.00mm (+ 0.24") |
| ③ + 1.00mm (+ 0.04") | ⑦ + 8.00mm (+ 0.32") |
| ④ + 3.50mm (+ 0.14") | ⑧ + 8.50mm (+ 0.33") |
| | ⑨ + 9.00mm (+ 0.35") |

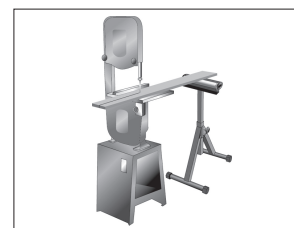
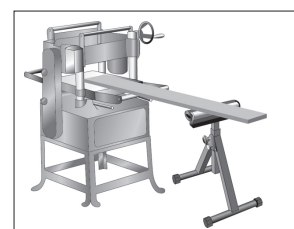
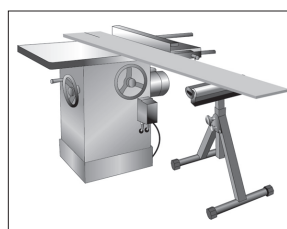
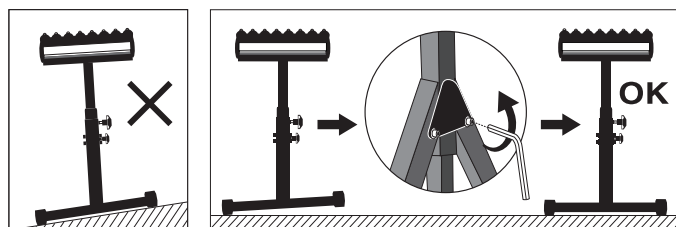
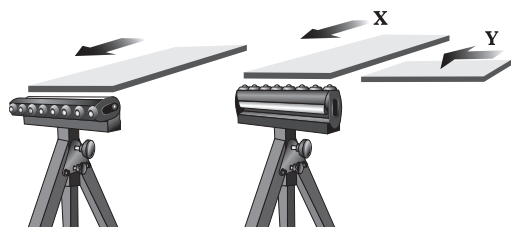
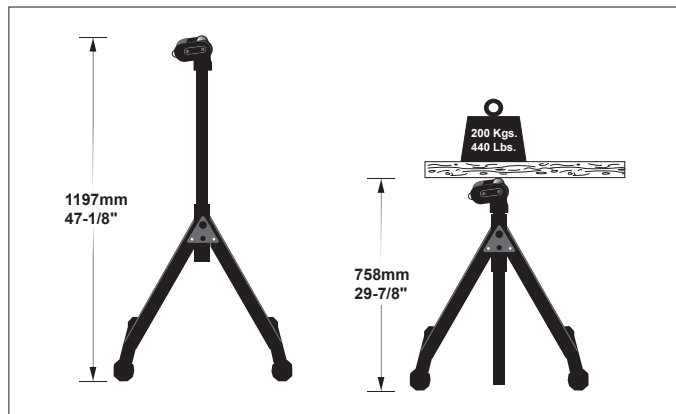